

From Eye to Insight



3D Digital Microscope

ARveo 8x

Technical Specifications



ELECTRICAL DATA

Power connection for ARveo 8x	1300 VA, 100 V – 240 V / 50–60 Hz integrated circuit breaker
Protection class	Class 1

MICROSCOPE FEATURES

Magnification	6:1 zoom, motorized, manual adjustment option, status displayed in the display of the optics carrier
Objective / working distance	225–600 mm, motorized multifocal lens, continuously adjustable, manual adjustment option, status displayed in the display of the optics carrier
Objective lens	Apochromatic
Eyepieces	Wide-field eyepieces for people wearing glasses 10× and 12.5× dioptic adjustment ±5 diopter settings adjustable eyecup
Illumination	Illumination system specially developed for microsurgical applications. Continuously variable illumination field diameter with Gaussian light distribution. Continuously adjustable brightness at constant color temperature.
Autolris	Automatic synchronization of the illumination field diameter according to the magnification factor. Using the manual override, the illumination field can be adjusted manually.
Main illumination	High-output xenon arc lamp 400 W, via fiber optics cable with independent power supply board.
Backup lamp	400 W xenon arc-lamp with redundant electrical high voltage part with independent power supply board.
BrightCare Plus	Safety function which automatically limits the maximum brightness depending on the working distance, controlled by a built-in luxmeter.
SpeedSpot	Laser focusing aid for fast and exact positioning of the microscope Laser Class 2 Wave length 635 nm Optical power < 1 mW
Fine focus	Available for back assistant
Magnification multiplier	1.4× (optional)

OPTICAL DATA

Zoom magnification

Type A binocular tubes, focal length (f) 162.66	Working distance				
	225 mm		600 mm		
	M_{tot}	FoV [mm]	M_{tot}	FoV [mm]	
Eyepiece 10×	min.	1.92	109.3	0.96	219.9
	max.	11.5	18.2	5.7	36.7
Eyepiece 12.5×	min.	2.40	88.5	1.19	178.0
	max.	14.4	14.7	7.2	29.7

Type B binocular tubes f170.0	Working distance				
	225 mm		600 mm		
	M_{tot}	FoV [mm]	M_{tot}	FoV [mm]	
Eyepiece 10×	min.	2.01	104.4	1.0	210.2
	max.	12.1	17.4	6.0	35.0
Eyepiece 12.5×	min.	2.51	84.5	1.25	170.1
	max.	15.1	14.1	7.5	28.35

Zoom magnification including magnification multiplier 1.4×

Type A binocular tubes f162.66	Working distance				
	225 mm		600 mm		
	M_{tot}	FoV [mm]	M_{tot}	FoV [mm]	
Eyepiece 10×	min.	2.7	78.1	1.34	157.1
	max.	16.1	13.0	8.0	26.2
Eyepiece 12.5×	min.	3.36	63.2	1.67	127.2
	max.	20.2	10.5	10.0	21.2

Type B binocular tubes f170.0	Working distance				
	225 mm		600 mm		
	M_{tot}	FoV [mm]	M_{tot}	FoV [mm]	
Eyepiece 10×	min.	2.8	74.6	1.4	150.1
	max.	16.9	12.4	8.4	25.0
Eyepiece 12.5×	min.	3.5	60.4	1.75	121.5
	max.	21.1	10.1	10.5	20.3

M_{tot} = total magnification FoV = Field of View Tolerances of ± 5%

Binocular tubes

Type	focal length	Binocular tube var.
Type A	f162.66	10448088: Binocular tube var. 0–80° 10446574: Inclined binocular tube 10446618: Inclined binocular tube 45°
Type B	f170.0	10446797: Binocular tube var. 30–150°
Type C	f131.65	10448386: Straight binocular tube

SELECTABLE OPTIONS

Microscope carrier

Rotation of optics	540°
Lateral tilt	50° to left / 50° to right
Inclination tilt	-30° / +120°
XY speed	Zoom linked XY speed
Brakes	> Full brake system > Selected brakes
Surgeon Information Panel	Quick overview of the most important microscope parameters like magnification, working distance, light intensity, fluorescence modes, and the recording and playback status.

ARveo 8x with ULT

FusionOptics	for increased depth of field for main surgeon and back assistant
Manual fine focus	for back assistant, ±5 diopter
Integrated 360° rotatable adapter	for main surgeon and back assistant binocular

M530 optics carrier with ULT for ARveo 8x

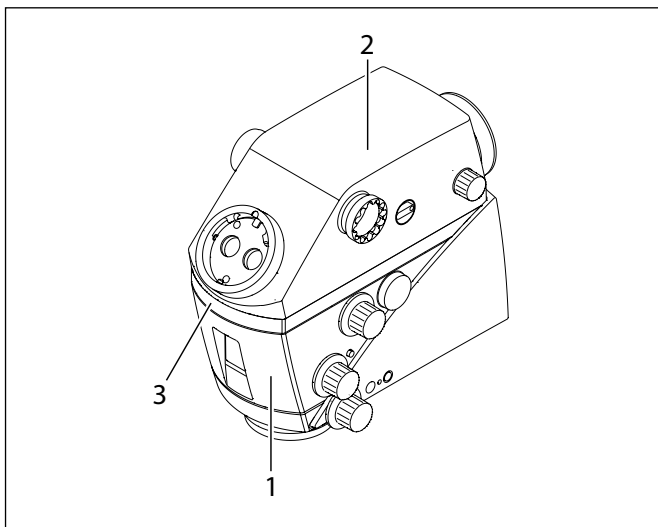

- 1 M530 optics carrier
2 ULT
3 Fluorescence module FL400 or FL560

Monitors for observation and heads-up surgery

microscope integrated	> 4K 2D 27-inch monitor > 4K 3D 32-inch monitor
external cart-mounted	4K 3D 55-inch monitor > integrated auto-focus > 3 digital zoom levels > integrated 4K upscaling software via HDSDI-connector

2D AND 3D VIEW

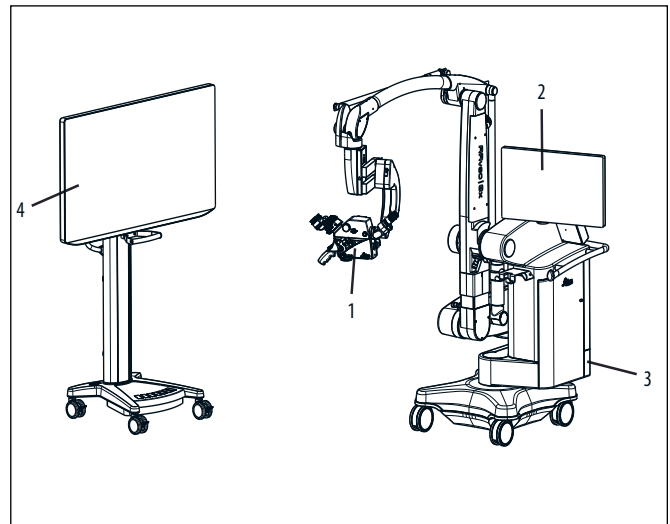

The optional Heads-up microsurgery accessory for ARveo 8x hybrid surgical microscope displays the surgical field in 2D or 3D (stereoscopic) on a visualization device.

The technology provides ergonomic advantages as the user can maintain an upright posture while observing the surgical field. The Heads-up Microsurgery accessory contains a cart-mounted monitor, which can be flexibly positioned to achieve optimal viewing positions. (Please see the Heads-up Microsurgery equipment user manual).

The external monitor on cart (4) can display a stereoscopic 3D images when used in conjunction with 3D glasses.

The stand monitor (2) can be supplied as a 2D or 3D configuration.



The 3D capable monitors automatically switch between 2D and 3D mode when required by the visualization.

LICENSES

Certain functions in the ARveo 8x are only activated if the following licenses are installed:

FL400:	Usage of FL400 mode activation from GUI, handles or foot switch, access to FL400 settings pages
FL560:	Usage of FL560 mode activation from GUI, handles or foot switch, access to FL560 settings pages
3D:	Use of 3D toggle on the Basic settings page, and 3D file export toggle
DICOM:	Functionality to set up and use export of patient data to external DICOM storage
GLOW800:	Usage of GLOW800 mode activation from GUI, handles or foot switch, access to multiple GLOW800 settings pages

- If the licenses are not pre-installed with the purchased microscope, they can be purchased from your Leica representative and later activated by an authorized Leica Microsystems service technician.

CAMERAS

Image sensor	4 × 1/1.2" inch
NIR camera	High-sensitivity, HD color camera

Camera image size with respect to the field of view

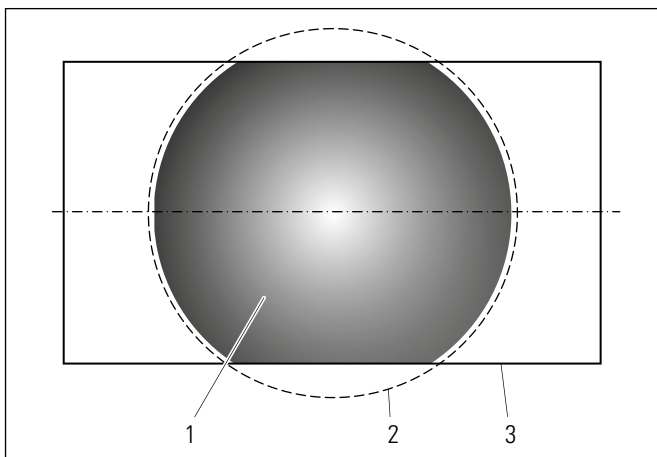

- 1 camera image size
2 field of view
3 screen size

Three available digital display options: Max. height, full width, and full screen.

FLOOR STAND

Type	Premium overhead floor stand with long reach, designed for stability and durability. Six electromagnetic brakes and air removal system.
Base	760 × 760 mm with four 360° rotating castors with a diameter of 150 mm each, one parking brake
Balancing	<ul style="list-style-type: none"> > Fully automatic balancing of the stand and optics carrier (OC) > Automatic intraoperative balancing of the OC > Manual balancing
Microscope operation via touch panel	Single graphical user interface for microscope operation and image acquisition, incl.: microscope and user settings, intraoperative adjustments, image acquisition and transfer, as well as review of recordings.
Safety hard keys	Hard keys, which are completely independent of the graphical user interface, are used to secure basic functions such as working distance, magnification, brakes, lighting and AutoBalance.
Light source	Dual Xenon arc-lamp illumination system and built in automatic lamp quick changer.
Control elements	<ul style="list-style-type: none"> > Pistol CAN handle with 10 functions for magnification, working distance, "All Brakes" button releases 6 brakes, side knob releases selected brake combinations, motorized side tilt (XY). All buttons except "All Brakes", are freely assignable. > Mouthswitch for releasing the selected brake combination. > Foot switch with 12-function.
Integrated imaging and documentation system	<p>Built-in 2D/3D Leica Recording System:</p> <ul style="list-style-type: none"> > Record in 2D or 3D quality utilizing a high compression with high bitrate compression file (60 MB/mn) and 2 TB storage space, corresponds to approx. 400 hours of video. > Quickly store images and export via USB > Optimized data processing and connectivity for DICOM /PACS
Connectors	Central connection panel with labeled connectors for video, IGS, endoscope and control data transfer. Internal power supply 12 VDC, 24 VDC and AC terminals. Open architecture for existing software upgrades and future software developments.

Carrier for monitor	700 mm long and flexible arm with 4 axes for rotation and inclination to carry an optional video monitor
Materials	Use of RoHS conform materials All solid metal construction, coated with a paint which provides an antimicrobial effect on surfaces.
Minimum height	In park position: 1950 mm
Range Cantilever	Max. 1925 mm
Load	Monitor arm: max. 16 kg Swing arm: min. 6.7 kg, max. 12.2 kg from microscope dovetail ring interface
Weight	335 kg total weight (without load)



The figure shows the camera image size with respect to the field of view for the visual video camera and the ARveo 8x NIR camera. Please be aware that the field of view is not fully covered by the documentation system.

AMBIENT CONDITIONS

In use	+10 °C to +30 °C +50 °F to +86 °F 30% to 95% rel. humidity 800 mbar to 1060 mbar atmospheric pressure
Storage	-40 °C to +70 °C -40 °F to +158 °F 10% to 100% rel. humidity 500 mbar to 1060 mbar atmospheric pressure
Transport	-40 °C to +70 °C -40 °F to +158 °F 10% to 100% rel. humidity 500 mbar to 1060 mbar atmospheric pressure

LIMITATIONS OF USE

The ARveo 8x may be used only in closed rooms and must be placed on a solid floor. The ARveo 8x is not suitable for crossing thresholds higher than 10 mm. To move the surgical microscope over thresholds of 10 mm, the wedge (1) included in the packaging can be used.

- Loosen the screws (2) on one side of the hinge to remove the wedge (1).

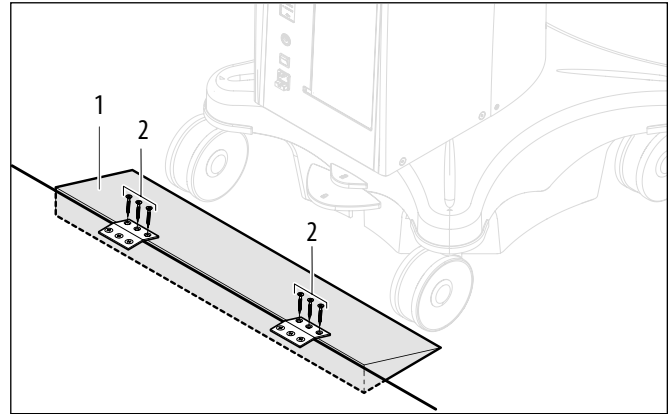

- Place the wedge (1) in front of the threshold.
- Move the surgical microscope across the threshold in transport position, pushing it by the handgrip.

Without auxiliary equipment, the ARveo 8x can be moved across thresholds up to a max. height of 5 mm.









IGS / ENDOSCOPE

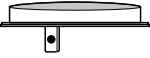

Interface/ Compatibility	Open architecture for IGS & endoscope systems
Input Interface	Type: DVI-I
Compatible with	> DVI 1.0 > HDMI 1.4a (with DVI to HDMI adapter, not included) > VGA (with DVI to VGA connector, included)
Resolution	up to 1920 × 1200
Frame rate	up to 144 fps
Color depths	8-bit
Color format (VGA)	RGB
Color samplings (HDMI)	RGB 4:4:4

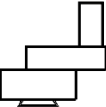
ACCESSORIES

A comprehensive range of accessories enables the ARveo 8x surgical microscope to be matched to the requirements of the task in hand. Your Leica representative will be pleased to help you select the appropriate accessories.

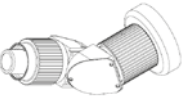
Devices and accessories manufactured by Leica

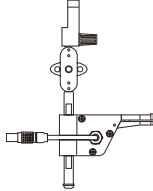
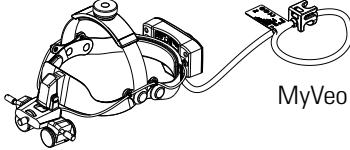
Picture	Devices and accessories
	Protective glass
	Binocular tube var. 0° – 180°, T, Type II
	Binocular tube var. 30° – 150°, T, Type II L
	Inclined binocular tube, T, Type II
	Straight binocular tube, T, Type II
	Inclined binocular tube 45°, Type II
	Eyepiece 10x
	Eyepiece 12.5x
	1.4x magnification multiplier
	Stereo attachment second observer

Picture	Devices and accessories
	Mouth switch
	MyVevo headset
	See also the corresponding user manuals.

DIMENSIONAL DRAWING

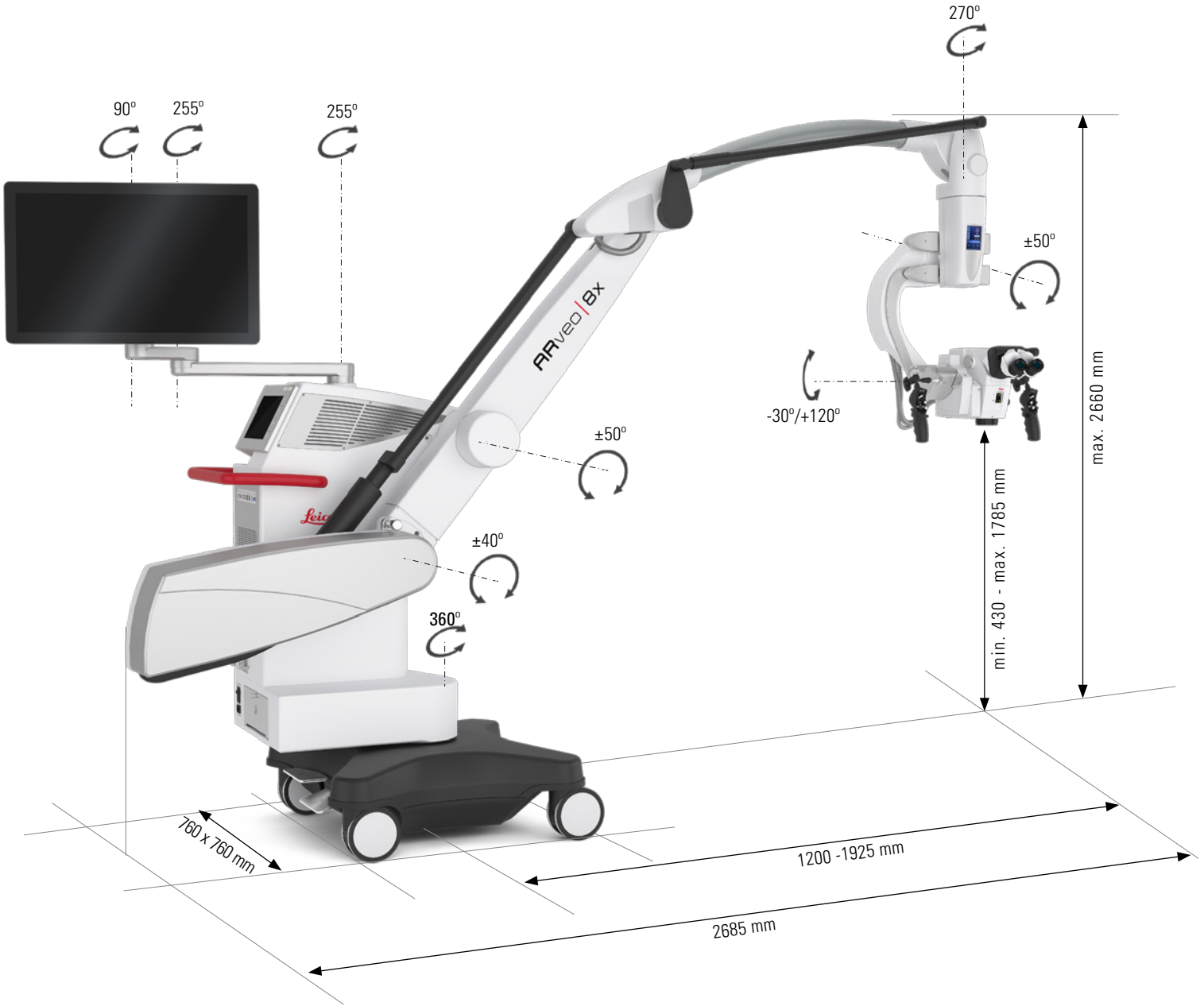

Specifications in mm



Leica Microsystems (Schweiz) AG
Max Schmidheiny-Strasse 201
9435 Heerbrugg, Switzerland



Class IIa ARveo 8x and GLOW800

Class I Surgical microscope accessories

Not all products or services are approved or offered in every market and approved labeling and instructions may vary between countries.
Please contact your local Leica representative for details.



Leica Microsystems (Schweiz) AG · Max Schmidheiny-Str. 201 · 9435 Heerbrugg ·
Switzerland · T +41 71 726 3333

<https://go.leica-ms.com/arveo8x>

CONNECT
WITH US!

