

# ライカ DMI 6000 Bの システム ダイアグラム

## TVシステム

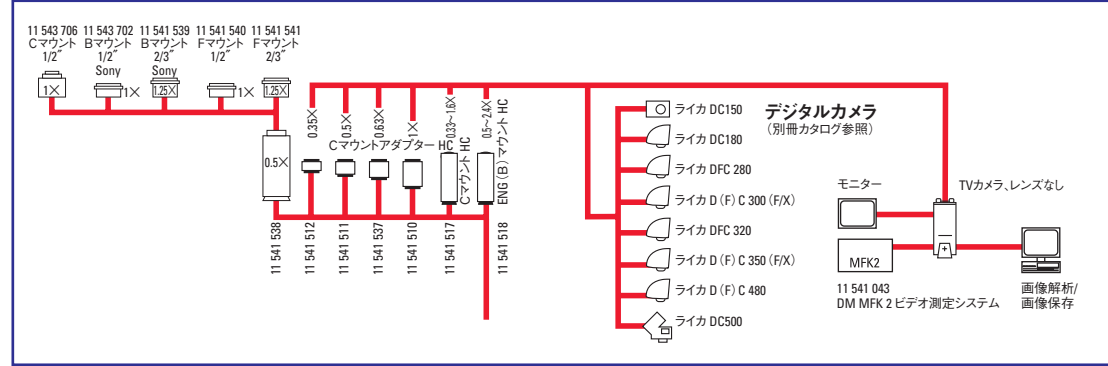

## コンデンサー

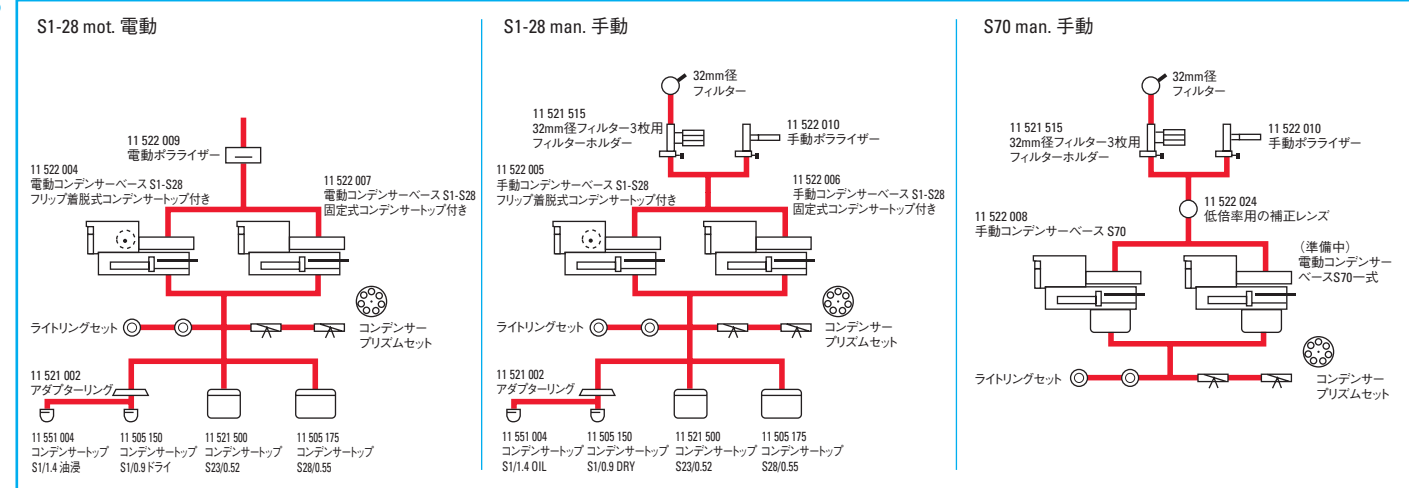

## 双眼エルゴ鏡筒付き

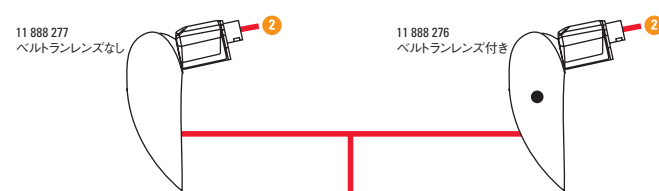

## 三眼エルゴ鏡筒付き

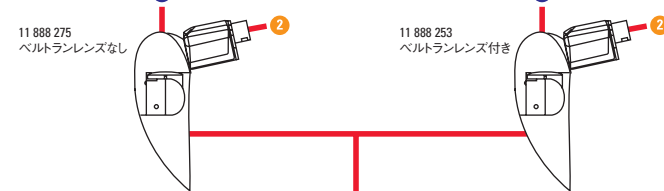

## 鏡基\*



## 鏡基\*、IMC-レンズシステム付き



## 鏡基\*



## 鏡基\*、IMC-レンズシステム付き



## サイドポート

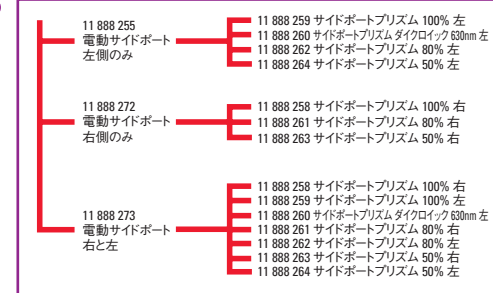

## マイクロナンピューレーター M

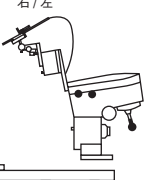

11 522 040 ライカ DMI 6000 B用底面プレート

## 透過光路

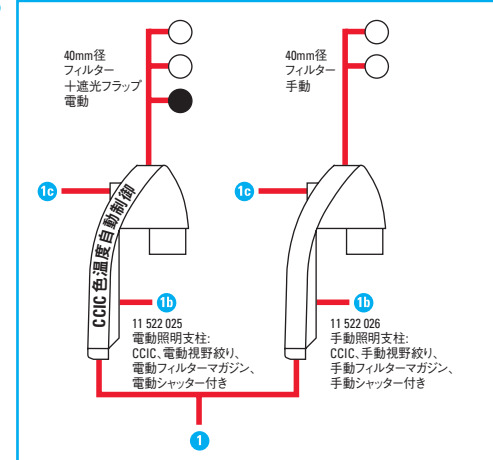

## 透過光ランプハウス

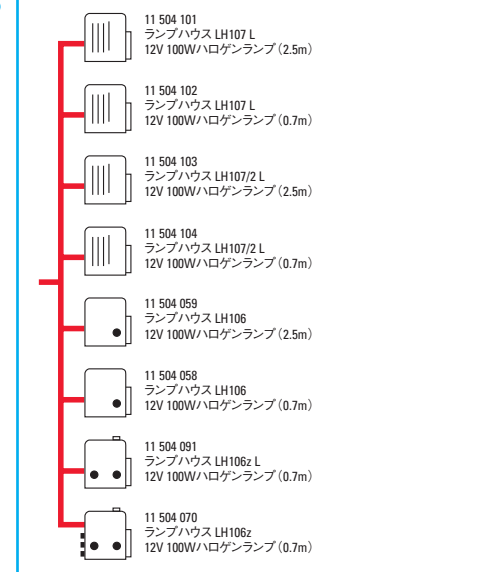

## 接眼レンズ

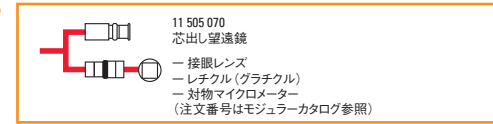

## 対物レンズ

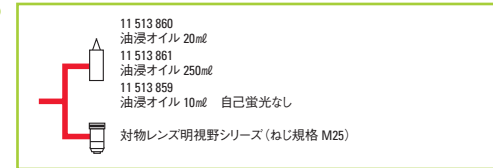

## 底面プレート

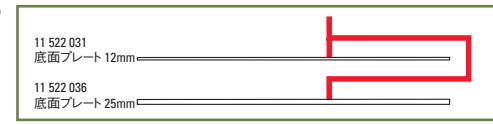

## 蛍光ランプハウス

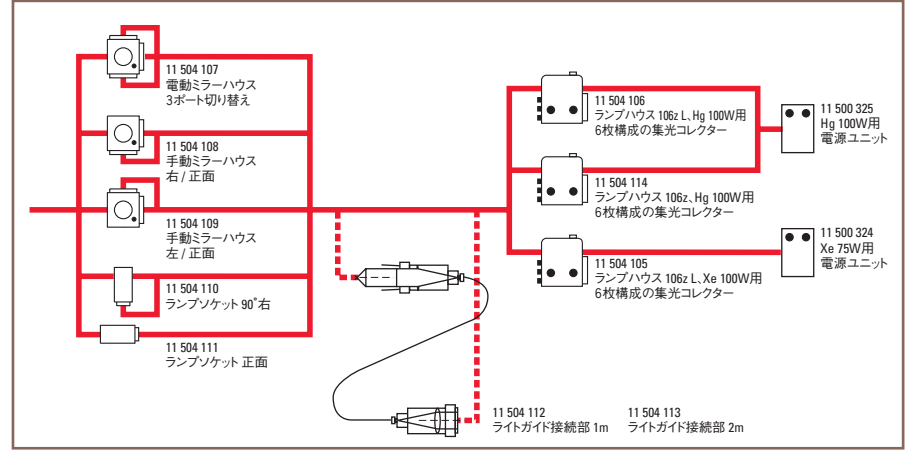

## 蛍光光路と中間倍率チェンジャー

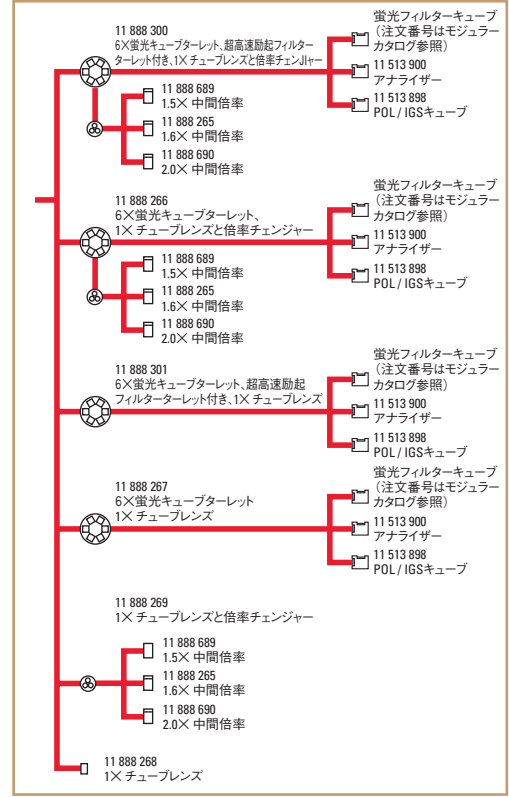

## 蛍光ブースターレンズ



## IMCシステム

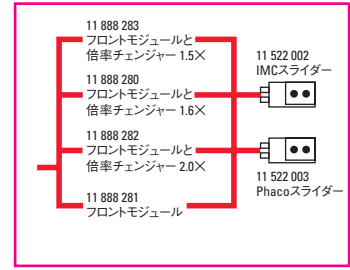

## DICシステム

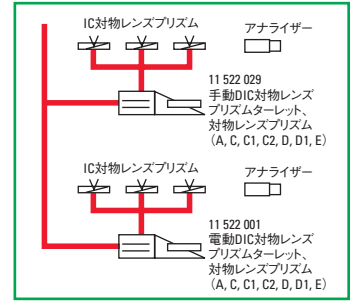

## 試料ステージ

