



Leica F12 I User Manual

Table of Contents

General Instructions	3
Safety Concept	4
Symbols Used	5
Safety Instructions	6

Floor Stand

Introduction	9
Overview (Sample Configuration)	10

Installation

Pedestal and Large Vertical Column	12
Large Horizontal Arm and Flex-arm	13
Small Vertical Column: Assembly	14
Small Vertical Column: Montage	15
Small Vertical Column: Height Adjustment	16
Focusing Arm: Configuration 1 for Table Inspections	17
Focusing Arm: Configuration 2 for Table Inspections	18
Focusing Arm: Configuration 3 for Table Inspections	19
Focusing Arm: Configuration 1 for Wall Inspections	20
Alternative: Variable Focusing Arm	21

Microscop Installation

Optics Carrier and Objective	23
Tube and Eyepieces	24
Dioptric Correction and Parfocality	25

Operation

Adjusting the Joint Resistance	27
Balancing the Flex-arm	28
Adjusting the Working Height of the Microscope	29
Safe Transport	30

Illumination

(Optional) Leica LED1000 Combi Controller	33
Leica High-power Spotlight	35
Leica 2-arm LED Spotlight	36

Appendix

Care and Maintenance	38
Troubleshooting	39
Technical Data	40
Dimensions	41

General Instructions

Safety Concept

Before installing the Leica F12 I floor stand or using it for the first time, please read the "Safety Concept" brochure provided. It contains additional information on handling and care.

Use in clean rooms

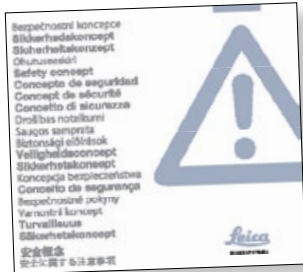

The Leica F12 I series can be used in clean rooms without any problems.

Cleaning

- Do not use any unsuitable cleaning agents, chemicals or techniques for cleaning.
- Never use chemicals to clean colored surfaces or accessories with rubberized parts. This could damage the surfaces, and specimens could be contaminated by abraded particles.
- In most cases, we can provide special solutions on request. Some products can be modified, and we can offer other accessories for use in clean rooms.

Servicing

- Repairs may only be carried out by Leica Microsystems-trained service technicians. Only original Leica Microsystems spare parts may be used.

Responsibilities of person in charge of instrument

- Ensure that the Leica floor stand is operated, maintained and repaired by authorized and trained personnel only.

Safety Concept

The Leica F12 I is shipped with an interactive CD-ROM, where you can find all relevant user manuals. Keep it in a safe place, and readily accessible to the user. User manuals and updates are also available for you to download and print from our web site www.leica-microsystems.com.

The "Safety Concept" brochure contains additional safety information regarding service work, requirements and the handling of the floor stand, the installed stereomicroscope, the electrical accessories as well as general safety instructions.

You can combine individual system articles with articles from external suppliers (e.g. cold light sources, etc.). Please read the user manual and the safety requirements of the supplier.

Before installing, operating or using the instruments, read the user manuals listed above. In particular, please observe all safety instructions.

To maintain the unit in its original condition and to ensure safe operation, the user must follow the instructions and warnings contained in these user manuals.

Symbols Used

Warning of a danger



This symbol indicates especially important information that must be read and complied with. Failure to comply can cause the following:

- Hazards to persons!
- Instrument malfunctions and damage.

Warning of hazardous electrical voltage



This symbol indicates especially important information. Failure to observe can cause the following:

- Hazards to persons!
- Instrument malfunctions and damage.

Danger due to hot surface



This symbol warns against touching hot surfaces, such as light bulbs.

Important information



This symbol indicates additional information or explanations that are intended to provide clarity.

Safety Instructions

Intended use

- Refer to the "Safety Concept" brochure.

Non-intended use

- Refer to the "Safety Concept" brochure.

The instruments and accessories described in this manual have been safety-tested and checked for possible hazards. The responsible Leica affiliate must be consulted whenever the instrument is altered, modified or used in conjunction with non-Leica components that are outside of the scope of this manual.

Unauthorized alterations to the instrument or noncompliant use shall void all rights to any warranty claims.

Installation location

- Refer to the "Safety Concept" brochure.
- Electrical components must be placed at least 10 cm away from the wall and from flammable substances.
- Avoid large temperature fluctuations, direct sunlight and vibrations. These conditions can distort measurements and micrographic images.
- In warm and warm-damp climatic zones, the individual components require special care in order to prevent the build-up of fungus.

Requirements to be met by the operator:

- Refer to the "Safety Concept" brochure.

Ensure that:

- The Leica F12 I is operated, maintained and repaired only by authorized and trained personnel.
- All operators have read, understood and observe this User Manual, and particularly the safety regulations.

Safety Instructions (continued)

Repairs, service work

- Refer to the "Safety Concept" brochure.
- Only original Leica Microsystems spare parts may be used.
- Before opening the instruments, switch off the power and unplug the power cable.
- Touching the live electric circuit can cause injury.

Transport

- Always use the original packaging for shipping or transporting the Leica F12 I.
- In order to prevent damage from vibrations, disassemble all moving parts that (according to the user manual) can be assembled and disassembled by the customer and pack them separately.



Because the pedestal of the Leica F12 I is particularly heavy, always request assistance from another person when transporting it!

Installation in third-party products

- Refer to the "Safety Concept" brochure.

Disposal

- Refer to the "Safety Concept" brochure.

Legal requirements

- Refer to the "Safety Concept" brochure.

EC Declaration of Conformity

- Refer to the "Safety Concept" brochure.

Leica F12 I Floor Stand

Introduction

Congratulations on purchasing the Leica F12 I by Leica Microsystems. The particular design of this floor stand makes it ideally suited for mobile examinations of specimens. Whether material inspection, quality control or art restoration—in fact anywhere you might need a mobile microscopy workstation, you will find that the Leica F12 I is a flexible, sturdy and cost-effective solution.

As versatile as your work

The Leica F12 I supports the Leica stereomicroscopes M50, M80 and the entire Leica S series. Not only are there many models to choose from, but there is also a range of accessories to fulfill every possible wish. Even if your requirements are like no one else's: Your Leica consultant will configure a workstation that meets your needs perfectly.

For more information about Leica Microsystems products and services and the address of your nearest Leica representative, please visit our website: www.leica-microsystems.com

Thank you for choosing our products. We hope that you will enjoy the quality and performance of your new floor stand.

Leica Microsystems (Schweiz) AG
Industry Division
CH-9435 Heerbrugg

Overview (Sample Configuration)

- 1 Rotary knob for joint brake
- 2 Small vertical column
- 3 Microscope
- 4 Pedestal
- 5 Castors with footbrakes
- 6 Cable holder
- 7 Small horizontal arm
- 8 Large horizontal arm
- 9 Storage compartment for power pack
- 10 Large vertical column
- 11 Brake knob for locking the vertical position
- 12 Rotary knob for balancing
- 13 Flex-arm

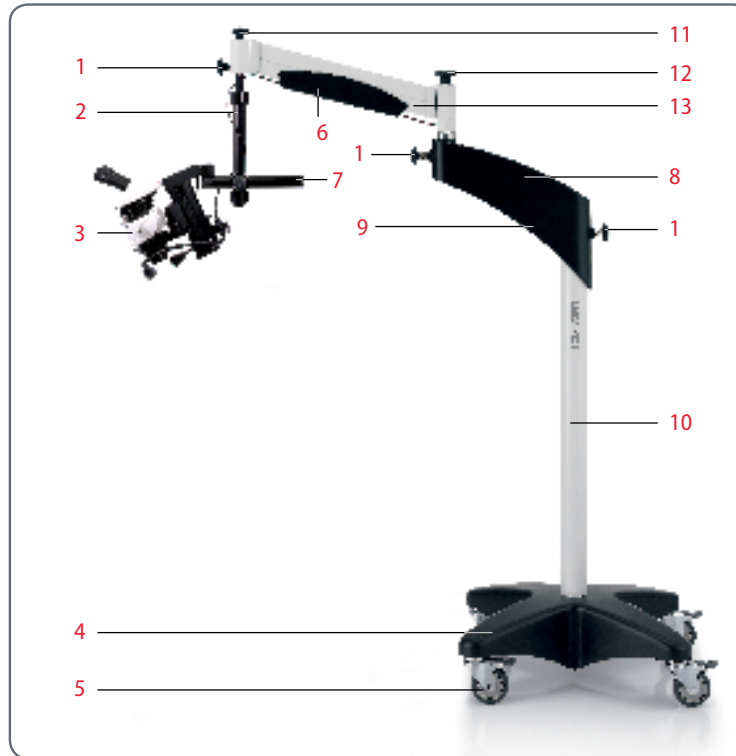

Installation

Pedestal and Large Vertical Column



An M5 Allen key is required for assembly (not provided).



The pedestal and the large vertical column are very heavy. Always request assistance for assembly!

Assembly

1. Move the pedestal to a flat, level surface and lock all 4 footbrakes.



2. Insert the large vertical column into the pedestal.



3. Use the Allen key to tighten both Allen screws.



4. Cover the screw holes using the cover caps.

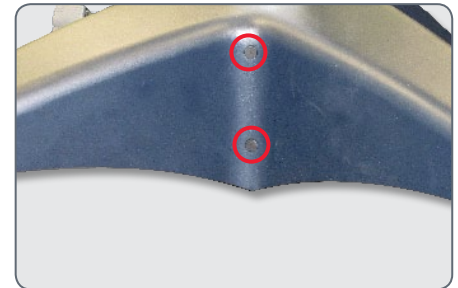

Large Horizontal Arm and Flex-arm



The large horizontal arm and the flex-arm are very heavy. Always request assistance for assembly!

Assembly

1. Place the large horizontal arm onto the large vertical column.



The large horizontal arm does not need to be fastened, because the weight of the structure ensures a secure connection.



Small Vertical Column: Assembly

 The small vertical column connects the Leica floor stand to the actual microscope assembly.

Assembly

1. Press the small vertical column onto the coupling piece from below.
2. Attach the small vertical column using the 4 Allen screws provided.



Small Horizontal Arm: Assembly

Assembly

1. Remove the wingscrew from the small horizontal arm.



2. Push the small horizontal arm through the hole in the small vertical column. Here, the beveled side must point in the direction of the outer knob.



3. Tighten the wingscrew.



4. Tighten both locking screws as much as necessary for your work.

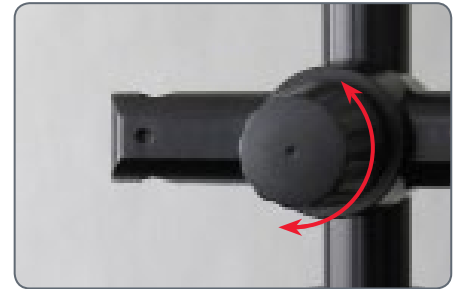

Small Horizontal Arm: Height Adjustment



Without exception, the two safety screws must never be removed!



Height adjustment

1. Hold the small horizontal arm securely.
2. Unscrew the safety ring.





3. Move the small horizontal arm to the desired position.
4. Tighten the safety ring.



The small horizontal arm can be set to any height. As necessary, it can be moved freely at the lower end of the column with the safety ring loosened.

Focusing Arm: Configuration 1 for Table Inspections

 In this configuration, the focusing arm is inserted from below. If necessary, the focusing arm can be set in a slanted position, for example if the specimen cannot be positioned horizontally under the microscope.

 For the greatest possible stability, you should extend the small horizontal arm as little as possible in order to reduce a lever effect.

Assembly

1. Push the holder of the focusing arm from below into the opening of the small horizontal arm.



2. Tighten the locking screw.



 For this configuration, the counter-screw must be locked tight with the washer at all times. Otherwise the entire microscope could fall onto the specimen!

3. Be sure to secure the focusing arm using the screw provided!



4. Unscrew both clamping screws on the focusing arm. Modify the tilt of the focusing arm and tighten the locking screw.



Focusing Arm: Configuration 2 for Table Inspections

Assembly

1. Push the holder of the focusing arm from the front into the opening of the small horizontal arm.
2. Unscrew both clamping screws on the focusing arm.
3. Modify the tilt of the focusing arm and tighten the locking screw.



Focusing Arm: Configuration 3 for Table Inspections

 In this configuration, the focusing arm is inserted from above. This results in a vertical view down on the specimen.

 For the greatest possible stability, you should extend the small horizontal arm as little as possible in order to reduce a lever effect.

Assembly

1. Push the holder of the focusing arm from above into the opening of the small horizontal arm.



2. Tighten the locking screw.



3. Unscrew both clamping screws on the focusing arm.



4. Tilt the focusing arm 90°.



5. Tighten the clamping screws on the focusing arm.

Focusing Arm: Configuration for Wall Inspections



Specimens on a wall or easel can best be examined using this assembly configuration.

Assembly

1. Extend the small horizontal arm far out and push the holder of the focusing arm from above into the opening.



2. Tighten the locking screw.



3. Additionally secure the focusing arm using the counter-screw and washer provided.



Alternative: Variable Focusing Arm

 The variable focusing arm makes it possible to tilt the entire microscope assembly quickly and safely.

 The assembly steps are identical to those for the basic focusing arm.

Adjusting the tilt

1. Hold the microscope securely.



Hold on to the microscope tightly while the clamping screw is being unscrewed. Otherwise it can tip forward abruptly and destroy the specimen!

2. Unscrew the clamping screw.



3. Tilt the microscope to the desired position.
4. Securely tighten the clamping screw.



Microscope Installation

Optics Carrier and Objective

Assembly

1. Insert the optics carrier into the focusing arm.



2. Securely tighten the clamping screw.



3. Screw the objective into the optics carrier.



Regularly check whether the clamping screw is still tight.

Tube and Eyepieces

Assembly

1. Place the tube onto the optics carrier.
2. Carefully tighten the clamping screw. The tube automatically shifts to the correct position when the screw is tightened.
3. Insert the eyepieces.
4. Secure the eyepieces using the clamping screws.



 Refer to the corresponding manuals for additional information on the individual instruments.

Dioptric Correction and Parfocality

 Leica stereomicroscopes are parfocally matched. A prerequisite for this is the correct setting of the diopters. The following adjustments have to be carried out only once by each user.

Therefore, all Leica eyepieces are also available with built-in dioptric correction, allowing the stereomicroscope to be used without glasses even by those with vision problems. The correction comprises ± 5 diopter settings.



Using the Dioptric Correction

1. Set the dioptric correction of both eyepieces to the mid position ("0" diopter settings).
2. Look through the eyepieces and focus on a flat specimen.
3. Rotate both eyepieces to the maximum value of "+5".
4. Hold one eye closed and rotate the other eyepiece in "-" direction until the specimen appears sharp.
5. Then, open the other eye and correct the diopter settings until the image is uniformly sharp.
6. Select the highest magnification and refocus if necessary.

Now, if you adjust the magnification from the lowest to the highest level, the specimen is always brought into sharp focus. If not, repeat the process.

The system is now parfocally matched to your eyes.

Operation

Adjusting the Joint Resistance

 Adjusting the joint resistance makes it possible to customize how easy or difficult it is to move the arm.

Adjusting the Joint Resistance

- Loosen the articulation brakes to make the corresponding element move more easily.
- Tighten the articulation brakes to make it harder to move the corresponding element.



Balancing the Flex-arm



For safety reasons, the flex-arm must be balanced after every adjustment to the configuration.



During the balancing process, be aware that the microscope side tends to be slightly lighter.



Never balance the flex-arm over a specimen.



The Leica F12 I is designed for weights between 1.5 kg and 6.5 kg.



The correct direction of rotation (lighter/heavier) is indicated below the rotary knob.

Balancing the Flex-arm

1. Hold the microscope securely.
2. Loosen the brake knob for the vertical position lock. The flex-arm is now released.
3. By manually moving the flex-arm, check whether the microscope side is too light or too heavy.
 - If the microscope is too heavy, turn the knob counterclockwise.
 - If the microscope is too light, turn the knob clockwise.



Adjusting the Working Height of the Microscope



Never adjust the working height over a specimen!

Adjusting the working height

1. Carefully release the brake knob on the front end of the flex-arm.



2. Move the microscope to the desired working height.
3. Tighten the brake knob.

Safe Transport

 If the floor stand begins to swing out of control, risk of injury results. For this reason, the Leica F12 I may only be moved with the flex-arm folded together and locked!

 Feet in lightweight shoes could become trapped beneath the casing of the base during transport!

Moving the floor stand

1. Position the flex-arm approximately horizontal.
2. Tighten the brake knob for the vertical position lock. The flex-arm is now locked.

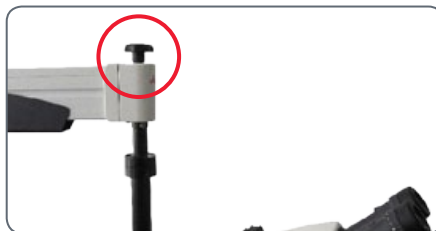

3. Remove the power cable.

4. Release the articulation brakes and fold the flex-arm together.



 Due to the rotation stop device, the flex-arm can be moved only in one direction above the large horizontal arm.

Safe Transport (continued)

5. With your foot, push up the footbrake release levers to release the footbrakes.

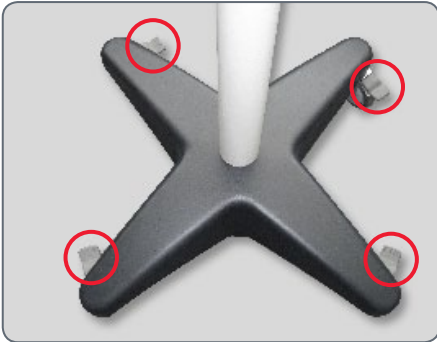

For safety reasons, always push the floor stand—never pull it.

6. Hold the floor stand securely by the column and push it to the desired location.
7. Lock all four footbrakes.
8. Connect the power cable.

Illumination

(Optional) Leica LED1000 Combi Controller

 The Leica LED1000 combi controller allows the operation of 2 Leica high-power spotlights and/or 1 Leica ring illuminator.

Assembling the combi controller

1. Using the screw provided, fasten the Leica combi controller to the connector piece on the small vertical arm.



2. Feed the power cable through the cable holder on the flex-arm.



3. Connect the power cable to the Leica combi controller and the power pack.



(Optional) Leica LED1000 Combi Controller (continued)

4. Store the power pack in the storage compartment of the large horizontal arm.





-  For additional information on operating the Leica LED1000 illumination, refer to the manual provided for this instrument.

Leica High-power Spotlight

 The Leica high-power spotlight can be attached either to the articulated arm (as illustrated here) or to the flexible gooseneck.

 The two threaded holes in the articulated arm have differing sizes. The smaller threaded hole is connected to the focusing arm and the larger to the spotlight.

 The LED of the Leica high-power spotlight becomes only slightly warm during operation. Nevertheless, be sure that the specimen cannot be damaged by coming too close to the light.

 Always hold the high-power spotlight securely when releasing the articulated arm. Otherwise it can tip downward abruptly and destroy the specimen!

Assembly

1. Screw the articulated arm into the threaded hole on the underside of the focusing arm.



2. Attach the spotlight to the articulated arm.
3. Connect the power pack for the spotlight to the Leica combi controller.

4. Release the articulated arm and aim the spotlight in the desired direction.



5. Secure the power cable using the Velcro strips provided so that the cables cannot get in the way during work.

Leica 2-arm LED Spotlight

 The Leica 2-arm LED spotlight is equipped with two LED lamps. It only uses one terminal, however, on the Leica combi controller.

 For installation, the focusing arm must be removed. In doing so, request assistance from another person and be sure that the specimen is not located directly below the microscope.

 The LEDs of the Leica 2-arm LED spotlight become only slightly warm during operation. Nevertheless, be sure that the specimen cannot be damaged by coming too close to the light.

Assembly

1. If the focusing arm has already been installed, remove it (see pages 17–19).
2. Screw the installation ring onto the spotlight.



3. Slide the installation ring over the small horizontal arm and tighten the locking screw.



4. Install the focusing arm.
5. Connect the power pack for the spotlight to the Leica combi controller.
5. Secure the cables using the Velcro strips provided so that the cables cannot get in the way during work.

Appendix

Care and Maintenance

General

- For good optical results, it is important to keep optical components clean.
- Always cover the stereomicroscope with the dust cover included in the delivery when the instrument is not in use.
- If an optical surface is very dirty or dusty, flush it using a syringe or clean it using a camelhair brush before attempting to wipe it off.
- Optical surfaces should be cleaned using a lint-free cloth, lens cloth or cotton swab soaked in methanol or a commercially available glass cleaner. Do not use alcohol.
- Avoid excessive use of solvents. The lint-free cloth, lens cloth or cotton swab should be soaked with solvent, but not so wet that solvent runs over the lens.

Troubleshooting

Malfunction	Possible cause	Correction
The flex-arm moves up or down by itself.	The flex-arm is not correctly balanced.	Balance the flex-arm (see page 28).
The flex-arm sinks even at the highest level of the balancing scale.	Total weight of accessories and microscope is too high.	Reduce the total weight.
	Gas spring is defective.	Have the gas spring replaced by Leica service.
The microscope can either not be moved, or only with great physical effort.	The articulation brakes are too tight.	Loosen the articulation brakes (see page 27).

Technical Data

Leica F12 I	
Type	Compact floor stand with 4 castors that can be locked into place
Dimensions of the base	608 × 608 mm
Maximum load	6.5 kg (at the holder)
Load capacity	1.5 – 6.5 kg (at the holder)
Maximum horizontal extension	1224 mm
Vertical positioning range of the flex-arm	500 mm
Minimum instrument height (for transport)	1680 mm
Stand weight	Approx. 100 kg (without attachments)
Interface to focusing arms/drives:	5/8" (15.8 mm)
Interface for illuminators	M6 threaded hole for LED1000 combi controller

Dimensions

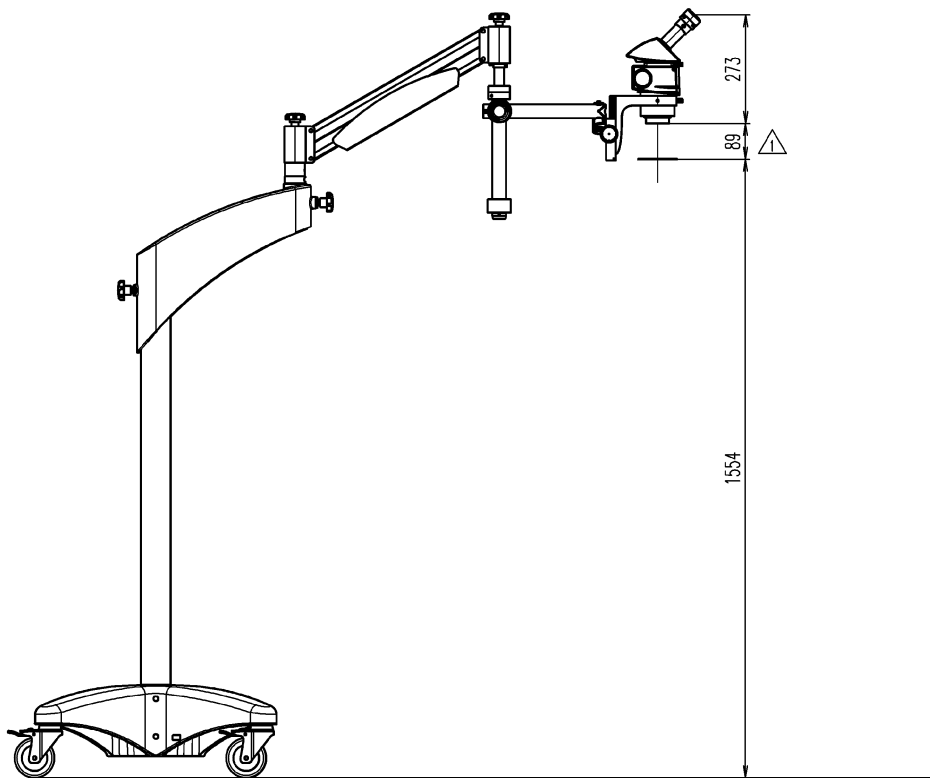

Dimensions (continued)

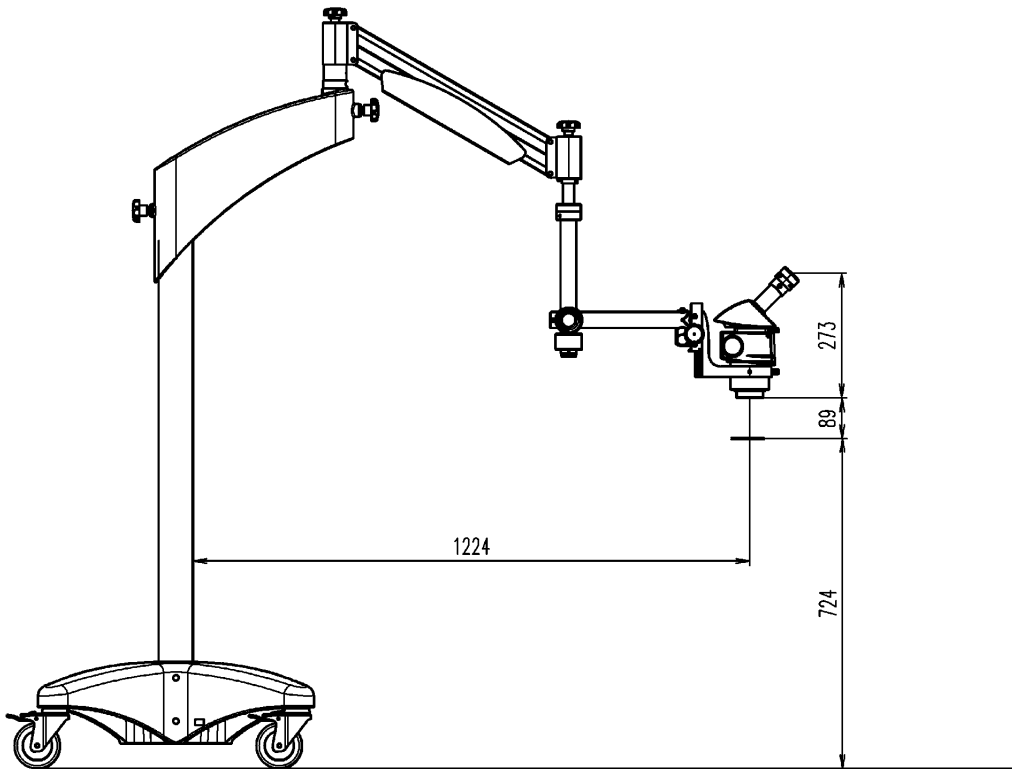

Dimensions (continued)

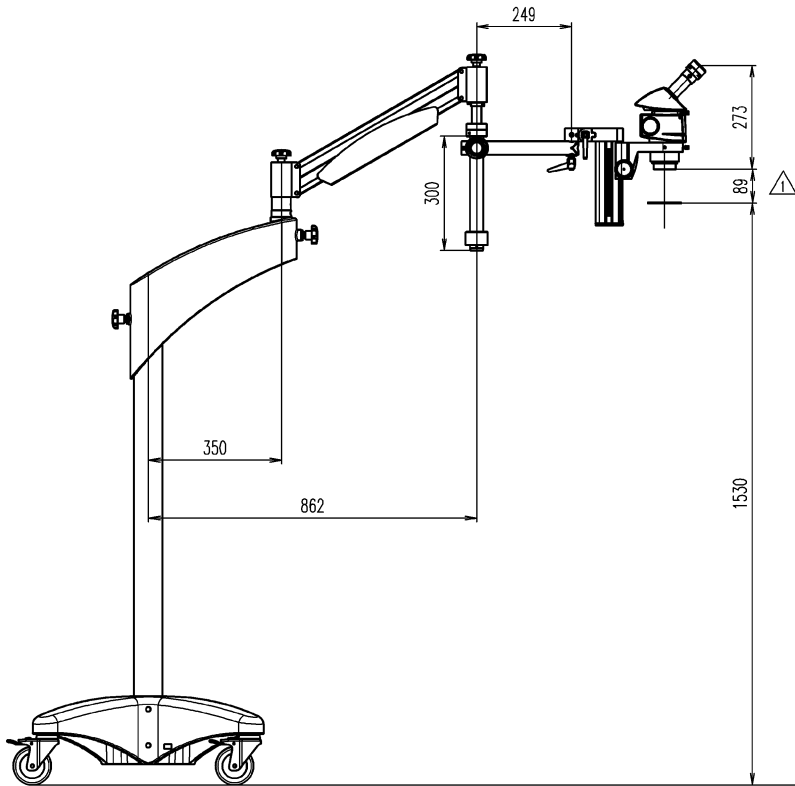

Dimensions (continued)

