

Living up to Life

**Leica**  
MICROSYSTEMS

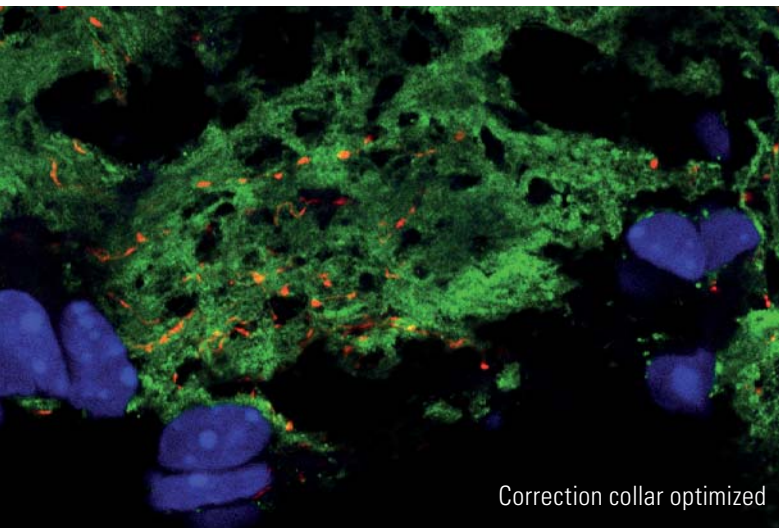

Correction collar optimized

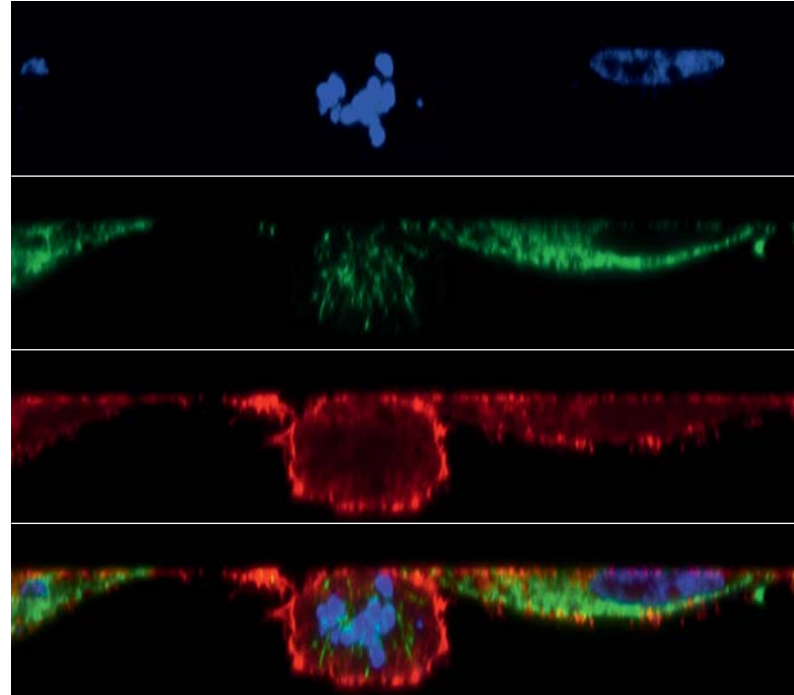
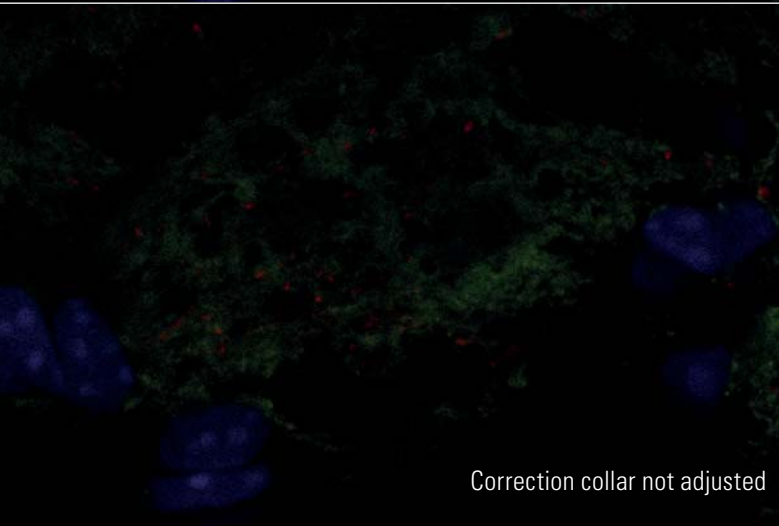

Correction collar not adjusted

## Leica motCORR™ Objectives

The Leica motCORR™ objectives provide superior color correction and field flatness based on Leica's plan apochromatic (PL APO) optics for the best imaging results. Their motorized correction collar simplifies the workflow by quickly adjusting the optics to adapt to varying coverglass thickness, changing temperature, and specimen inhomogeneities.

- › The motorized correction collar improves the performance of high numerical aperture (NA) water immersion objectives for bright, high-resolution images
- › The precise, robust motor provides accurate adjustment for thousands of turns
- › Remote control of the Leica motCORR™ quickly adjusts the optics without disturbing the specimen and minimizes training effort

[www.leica-microsystems.com](http://www.leica-microsystems.com)

# Motorized Correction Collar for the Best Optical Performance in 3D

Confocal laser scanning microscopy couples high-resolution imaging in xy with the ability to resolve objects in the third (z) dimension. This performance is optimal when the refractive indices of the specimen and all intermediate optical media match.

Changes in coverglass thickness and temperature as well as inhomogeneous, thick specimens introduce refractive index mismatches. This causes deterioration of the point-spread function, geometric distortion, and spherical and chromatic aberration. These effects limit penetration depth, contrast, and intensity of the confocal images. The Leica motCORR™ objectives provide fast and precise adjustment of the optics to restore optimal imaging conditions.

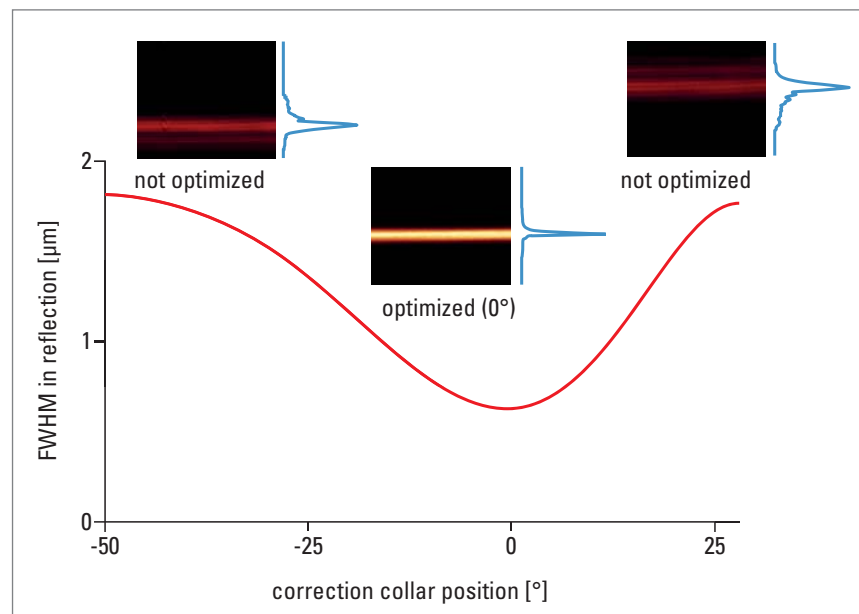

Plot of the full width half maximum (FWHM) in reflection at different settings of the correction collar as determined from xz scans. Suboptimal adjustment relative to the optimal position (0°) drastically reduces resolution and signal intensity.

## SUPERIOR OPTICS FOR HIGH-RESOLUTION IMAGING IN THREE DIMENSIONS

Imaging in aqueous samples, such as living cells and tissues, requires high NA water immersion objectives. These objectives are highly sensitive to refractive index variations. A correction collar axially moves the central lens group and restores optimal image resolution and brightness. Manual adjustment requires time and experience, and is challenging when access to the objective is obstructed by additional equipment. The Leica motCORR™ simplifies adjustment of the correction collar and reduces training effort.

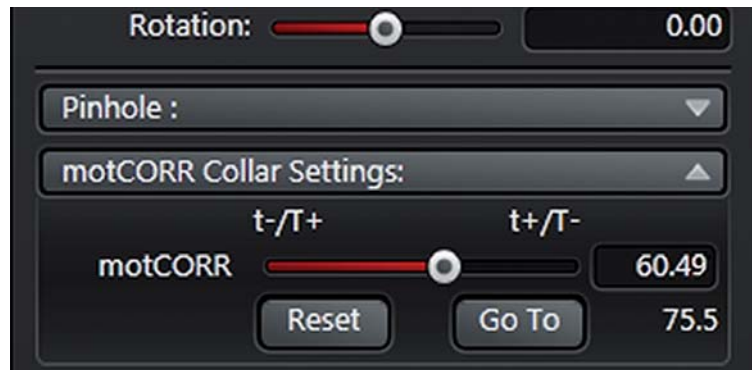

### PRECISE CORRECTION FOR THOUSANDS OF TURNS

The correction collar of the Leica motCORR™ objective is driven by a precise and robust motor. It is designed to provide the most reliable adjustment of the lenses and adapts for coverglass thickness from 0.14 to 0.18 mm.

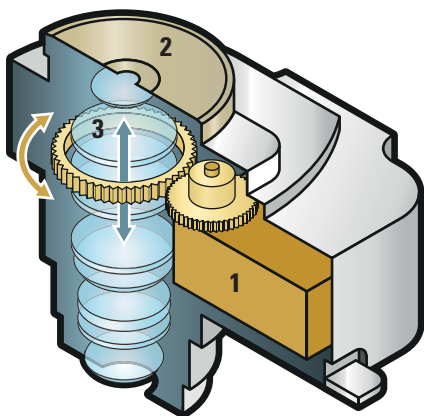

### SOFTWARE-CONTROLLED CORRECTION SIMPLIFIES WORKFLOW

The Leica motCORR™ is easily remote-controlled by the control panel and by LAS AF (Leica Application Suite Advanced Fluorescence) microscope software. This ensures that the specimen remains undisturbed during movement of the correction collar.

1 motor

2 water cap

3 lens group adjusts to correct for changes in coverglass thickness, temperature, etc.

### FAST ADJUSTMENT LEAVES MORE TIME FOR THE EXPERIMENT

Positioning the correction collar is fast and reduces the time spent on experiment setup. Optical correction adjustments with the Leica motCORR™ are performed quickly and easily with the SuperZ galvo stage, which allows acquisition of live xz-scans. Store the motCORR™ position and conveniently recall it for later use.

Leica motCORR™ for your applications

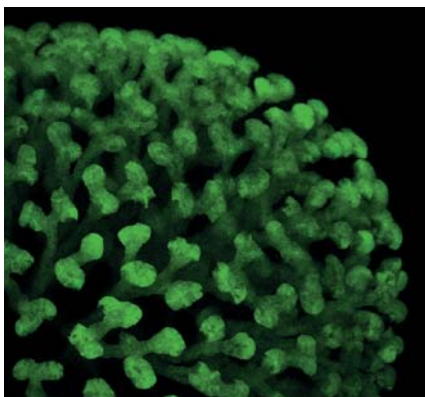
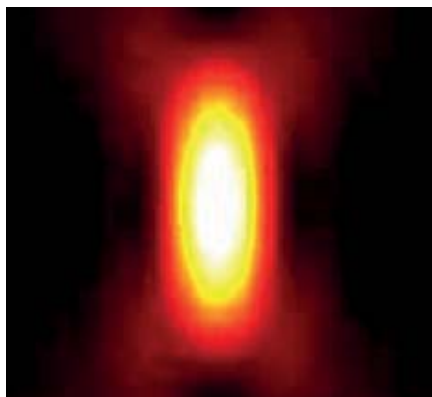

LEICA TCS SP8 SMD WITH FCS

LEICA TCS SP8 MP

LEICA WATER IMMERSION MICRO DISPENSER  
LEICA DMI6000 WITH AFC

The best spherical and chromatic correction for FCS:

Reliable and reproducible fluorescence correlation spectroscopy (FCS) data requires a confocal volume that closely resembles the mathematical model used in the FCS analysis.

- › Leica motCORR™ objectives are based on Leica PL APO optics, featuring excellent spherical and color correction for FCS and FCCS (Fluorescence Cross-Correlation Spectroscopy).
- › High numerical aperture ensures a small confocal volume for FCS.

Brighter images from thick tissues with multiphoton microscopy:

Adjustment of the correction collar to the refractive index of the specimen allows imaging of deeper tissue sections with increased brightness and better contrast.

- › The Leica motCORR™ is remotely adjusted without disturbing the specimen.
- › Large free working distance of up to 0.65 mm accommodates large specimens and deep tissue imaging.

The perfect match for live cell imaging:

Optimal results for live cell research and screening applications are achieved with high-resolution water immersion objectives. However, water quickly evaporates at 37°C. Leica's Water Immersion Micro Dispenser automatically adds water during a running experiment to provide stable water immersion.

The adaptive focus control (AFC), also compatible with the Leica motCORR™, ensures perfect focus positioning for long term experiments on the inverted microscope stand Leica DMI6000.

Available objectives for use with the Leica DMI6000 inverted microscope stand:

- HC PL APO 40x/1.10 W motCORR CS2
- HC PL APO 63x/1.20 W motCORR CS2